

## InMax ¼ turn actuators – size M

Electrical rotary actuators for use in safe areas

3-pos. / 0...10 VDC / 4...20 mA control mode, with feedback, 24...240 VAC/DC, 95° angle of rotation  
50/75 Nm, 100 Nm without and 30 Nm, 50 Nm with safety operation (spring return)

InMax - ... - Y  
InMax - ... - YF  
InMax - ... - CTM  
InMax - ... - VAM

Subject to change!

## Compact. Easy installation. Universal. Cost effective. Safe.

Type	Torque	Supply	Motor running time	Spring return	Control mode	Feedback	Wiring diagram
InMax- 50.75 - Y	50 / 75 Nm	24...240 V AC/DC	40 / 60 / 90 / 120 / 150 s/90°	–	3-pos., 0...10 V DC, 4...20 mA	0...10 V DC, 4...20 mA	SB 4.0/4.1
InMax-100 - Y	100 Nm	24...240 V AC/DC	40 / 60 / 90 / 120 / 150 s/90°	–	3-pos., 0...10 V DC, 4...20 mA	0...10 V DC, 4...20 mA	SB 4.0/4.1
InMax- 30 - YF	30 Nm	24...240 V AC/DC	40 / 60 / 90 / 120 / 150 s/90°	~ 20 s/90°	3-pos., 0...10 V DC, 4...20 mA	0...10 V DC, 4...20 mA	SB 4.0/4.1
InMax- 50 - YF	50 Nm	24...240 V AC/DC	40 / 60 / 90 / 120 / 150 s/90°	~ 20 s/90°	3-pos., 0...10 V DC, 4...20 mA	0...10 V DC, 4...20 mA	SB 4.0/4.1
InMax- ... - CTM	Types as above with aluminium housing and seawater resistant coating (cable glands brass nickel-plated)						
InMax- ... - VAM	Types as above with stainless steel housing for aggressive ambient (cable glands brass nickel-plated)						

### Product views and applications

Safety damper



Ball valve



Throttle valve

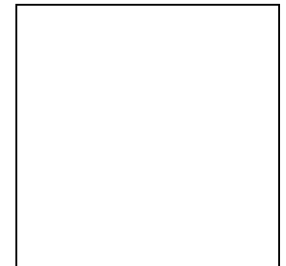

### Description

The InMax actuators are a revolution for safety, control and shut-off dampers, VAV systems, ball valves, throttle valves and other motorized applications for HVAC systems in chemical, pharmaceutical, industrial and offshore/onshore plants.

IP67 protection, small dimensions, only 9,5 kg weight, universal functions and technical data, an integrated heater and an optional stainless steel housing guarantee safe operation even under difficult environmental conditions. High quality brushless motors guarantee long life.

All actuators are programmable and adjustable on site. Special tools or equipment are not required. Motor running times and torques as well as spring return times, according to the actuator type, are selectable or adjustable on site. The integrated universal power supply is self adaptable to input voltages in the range of 24...240 VAC/DC. Furthermore it is possible to perform control signal inverting and compulsion control by certain connections. The actuators are 100 % overload protected.

...Max...-YF actuators are equipped with spring return fail safe function. Standard shaft connection is a double square direct coupling with 16 x 16 mm.

Different accessories are available to adapt auxiliary switches, terminal boxes or adaptions for ball valves and throttle valves and other armatures.

### Highlights

- ▶ Industrial use
- ▶ Universal supply unit from 24...240 VAC/DC
- ▶ 5 different motor running times 40–60–90–120–150 s/90°, adjustable on site
- ▶ 2 different spring return running times ~ 20 s/90°, selectable on site
- ▶ 3-pos. and 0...10 VDC, 4...20 mA control mode with or without spring return function
- ▶ Feedback signals 0...10 VDC and 4...20 mA
- ▶ Reverse function
- ▶ 30–50–75–100 Nm actuators in the same housing size
- ▶ 100 % overload protected
- ▶ Compact design and small dimension (L x W x H ~ 288 x 149 x 116 mm)
- ▶ Direct coupling to the damper shaft with double square connection 16 x 16 mm
- ▶ 95° angle of rotation inclusive 5° pretension
- ▶ Robust aluminium housing (optional with seawater resistant coating) or in stainless steel
- ▶ IP67 protection
- ▶ Simple manual override included + preparation for comfortable manual override
- ▶ Gear made of stainless steel and sinter metal
- ▶ Weight only ~ 9,5 kg
- ▶ Integrated heater for ambient temperatures down to -40 °C
- ▶ Integrated safety temperature sensor
- ▶ Integrated equipment for manual adjustment (push button, lamp, switch)
- ▶ Preparation for adaptable and adjustable auxiliary switches type ...Switch
- ▶ Wide range of accessories

Technical data	InMax- 50.75 -Y	InMax- 100 -Y	InMax- 30 -YF	InMax- 50 -YF
Torque motor (min.)	50 / 75 Nm selectable on site	100 Nm	30 Nm	50 Nm
Torque spring (F)	–	–	min. 30 Nm	min. 50 Nm
Torque blockade	In blockade and end positions torques are higher than above specified torques for motor and spring.			
Dimensioning of external load	Upon spring return the external load should be max. 80 % of torque spring (F), but min. 10 Nm			
Supply voltage / frequency	24...240 VAC/DC $\pm$ 10 %, self adaptable, frequency 50...60 Hz $\pm$ 20 %			
Power consumption	max. starting currents see ① Extra information (in acc. with voltage, $I_{start} \gg I_{rated}$ ), approx. 5 W holding power, approx. 16 W for heater			
Protection class	Class I (grounded)			
Angle of rotation and indication	95° incl. $\sim$ 5° pretension, mechanical value indication			
Working direction	Selectable by left/right mounting to the damper/valve shaft			
Motor running times	40 / 60 / 90 / 120 / 150 s/90° selectable on site			
Motor	Brushless DC motor			
Control mode Y	3-pos., 0...10 VDC, 4...20 mA in acc. with wiring, selectable on site. Galvanic separation between supply and Y-signal			
Feedback signal U	0...10 VDC, 4...20 mA in acc. with wiring, selectable on site, both signals are available at the same time			
Resistance of Y and U signals	<b>Input signal:</b> $U_Y$ 0...10 VDC at 10 k $\Omega$ , $Y_1$ 4...20 mA at 100 $\Omega$ . <b>Feedback signal:</b> $U_U$ 0...10 VDC at 2.000... $\infty$ $\Omega$ , $U_1$ 4...20 mA at 0...800 $\Omega$			
Reverse function	Bridge between wiring 3 and 4 (signal wise) gets a reverse function of Y and U			
Compulsion control	In modulation mode an On-off compulsion control can be performed by external connection /wiring independently from the modulating signal			
Adjustment of Y and U	In case of external mechanical limitation of the angle of rotation, it is possible to perform an adjustment drive started by touching the button			
Spring return (F)	–	–	spring return upon voltage interruption	
Spring return response time	–	–	up to 1 sec. after voltage interruption	
Spring return running time (F)	–	–	$\sim$ 20 s/90°	
Safety operations at 20 sec. (F)	–	–	min. 10,000 acc. to construction of damper and ambient	
Axle of the actuator	Double square 16 $\times$ 16 mm, direct coupling, 100 % overload protected			
Electrical connection	2 cables $\sim$ 1 m each, wire cross section 0.5 mm <sup>2</sup> , equipotential bonding 4 mm <sup>2</sup> . Connections require a terminal box!			
Diameter of cable	$\sim$ $\varnothing$ 7.1 + 7.4 mm	$\sim$ $\varnothing$ 7.1 + 7.4 mm	$\sim$ $\varnothing$ 7.1 + 7.4 mm	$\sim$ $\varnothing$ 7.1 + 7.4 mm
Cable gland	M16 $\times$ 1.5 mm			
Manual override	Use delivered socket wrench, max. 4 Nm			
Heater	Integrated, controlled heater for ambient temperature down to $-40$ °C			
Housing material	Aluminium die-cast housing, coated. Optional with seawater resistant coating (...-CTM) or stainless steel housing, № 1.4581 / UNS-J92900 / similar AISI 316Nb (...-VAM)			
Dimensions (L $\times$ W $\times$ H)	$\sim$ 288 $\times$ 149 $\times$ 116 mm, for diagrams see ① Extra information			
Weight	$\sim$ 9.5 kg aluminium housing, stainless steel $\sim$ 15 kg			
Ambients	Storage temperature $-40$ ... $+70$ °C, working temperature $-40$ ... $+50$ °C			
Humidity	0...90 % rH, non condensing			
Operation mode	80 % of ED are permitted (ED = duty cycle)			
Accuracy electrically	$\sim$ 100 steps			
Self adjustment	If you select 40 sec. or 60 sec. mode for motor running time or rotation angle $<$ 90° you need to start the self adjustment mode			
Maintenance	Maintenance free relative to function, maintenance must comply with regional standards, rules and regulations			
Wiring diagrams	SB 4.0 / 4.1	SB 4.0 / 4.1	SB 4.0 / 4.1	SB 4.0 / 4.1
Scope of delivery	Actuator, 4 screws M8 $\times$ 140 mm, 4 nuts M8, Allen key for simple manual override			
Parameter at delivery	50 Nm, 90 s/90°	100 Nm, 90 s/90°	30 Nm, 90 s/90°	50 Nm, 90 s/90°

### Approbations

CE identification	CE
EMC directive	2014/30/EU
Low voltage directive	2014/35/EU
Enclosure protection	IP67 in acc. with EN 60529

### Special solutions and accessories

...-CTM	Types in aluminium housing with seawater resistant coating, parts nickel-plated
...-VAM	Types in stainless steel housing, parts nickel-plated
InBox-Y/S...	Terminal boxes
MKK-M	Mounting bracket for boxes type ...Box-... directly on actuator
InSwitch	2 external aux. switches, adjustable
HV-MK	Comfortable manual override for ...Max actuators size M
AR-16-xx	Reduction part for 16 mm square connection to 14 or 12 mm shafts
Kit-S8	Cable glands nickel-plated
Adaptions	for dampers and valves on request

**Electrical connection**

All actuators are equipped with a universal supply unit working at a voltage range from 24...240 VAC/DC. The supply unit is self adjusting to the connected voltage!  
The safety operation of the spring return function works if the supply voltage is cut.  
For electrical connection a terminal box is required (e.g. InBox).  
An over-current protection fuse < 10 A has to be provided by installer.  
Note: the initial current is appr. 2 A for 1 second.

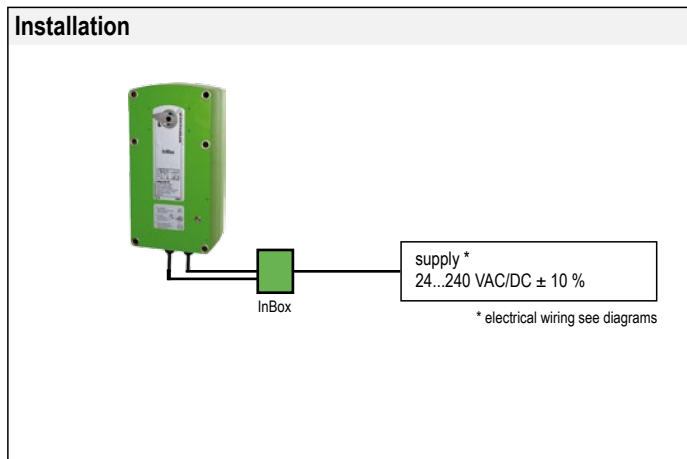
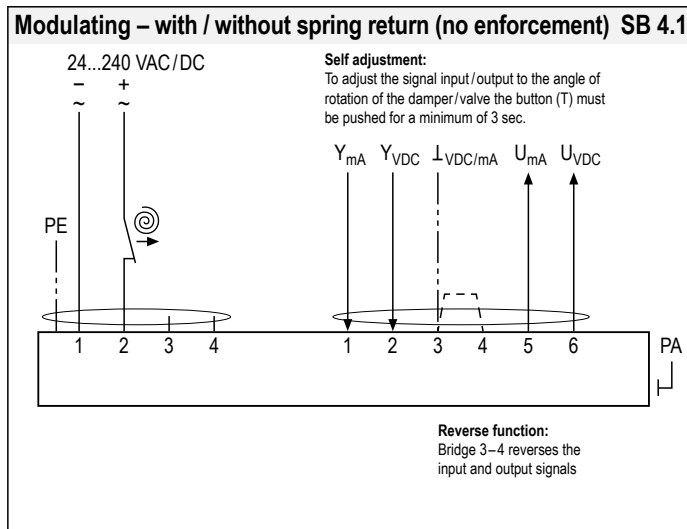
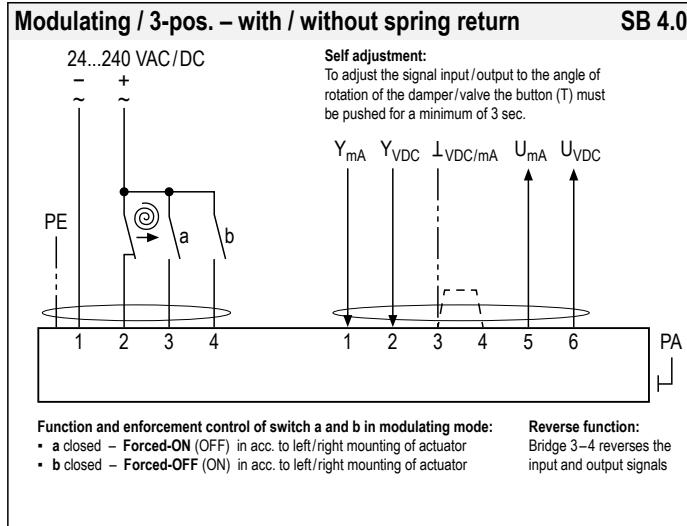

**Parameters, adjustments and failure indication**

**Switch – Push button – Lamp for adjustment (behind the blanking plug)**

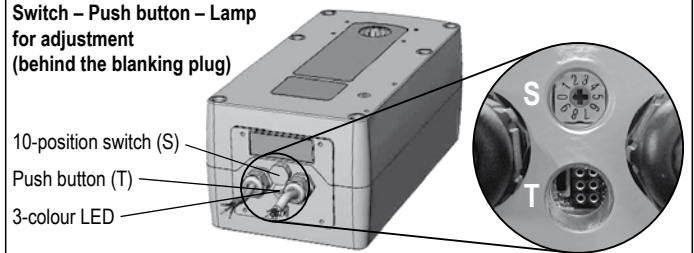

**Parameter selection**

Example:  
InMax-50.75-Y  
**Requested parameter:**  
Torque 75 Nm  
Motor running time 90 s/90°

Type	Torques	
InMax- 50.75-Y	50 Nm	75 Nm
InMax- 100-Y	100 Nm	
InMax- 30-YF	30 Nm	
InMax- 50-YF	50 Nm	

Running times	Position of switch S	
40 s/90°	00	05
60 s/90°	01	06
<b>90 s/90°</b>	02	<b>07</b>
120 s/90°	03	08
150 s/90°	04	09

**Result:**  
Switch position **07**

**Functions, adjustments and parameters**

**A) Self adjustment of angle of rotation**

Turn switch (S) to position 02 (low torque) or 07 (high torque). Press button (T) for a minimum of 3 seconds. The actuator drives to both end positions and detects the blocking positions. The LED flashes GREEN during adjustment.  
The adjustment takes about 180 seconds (90 sec. "On", 90 sec. "Off").

**B) Selecting motor running time and torque**

Adjust parameters only if actuator is in idle state or without applied potential.  
Turn switch (S) to the position required for the intended operation acc. to table above. The selected parameters will be carried out at the actuator's next operation.

**C) Changing modulating operation to 3-pos. operation with feedback**

Modulating mode: The LED lights GREEN, potential applied.  
Press button (T) briefly 3 times:  
• each for at least 0.2 seconds  
• altogether within max. 5 seconds

The LED changes from steady GREEN to steady YELLOW\*.

**D) Changing 3-pos. operation with feedback to modulating operation**

3-pos. mode: The LED lights YELLOW\*, potential applied.  
Press button (T) briefly 3 times.  
The LED changes from steady YELLOW\* to steady GREEN.

**E) Additional information for control in 3-pos. operation with feedback**

a closed, b open = direction I      a and b closed = motor doesn't work  
b closed, a open = direction II     a and b open = motor doesn't work  
The rotation direction (I and II) depends on left/right mounting of the actuator to the damper. To reverse the rotation direction (by motor) exchange the electrical wiring of terminal 3 and 4.

In 3-pos. operation with feedback the Y-inputs are without function.

**F) Inverting**

Bridging signal wires 3–4 (cable B) inverts the function of input signals Y and feedback signals U.

\* Note: "YELLOW" may vary from yellowish to orange.



**Attention**

During commissioning apply a self adjustment drive.  
Regard duty cycle at motor running times!  
Never use spring return actuators without external load.

### Important information for installation and operation

#### A. Installation, commissioning, maintenance

All national and international standards, rules and regulations must be complied with. Apparatus must be installed in accordance with manufacturer instructions. If the equipment is used in a manner not specified by the manufacturer, the safety protection provided by the equipment may be impaired.

For electrical connection a terminal box is required (e.g. InBox-...).

**Attention:** If the actuator is put out of operation all rules and regulations must be applied. You have to cut the supply voltage before opening the terminal box!

The cables of the actuator must be installed in a fixed position and protected against mechanical and thermal damage. Connect potential earth. Avoid temperature transfer from armature to actuator! Close all openings with min. IP67.

For outdoor installation a protective weather shield against sun, rain and snow should be applied to the actuator as well as a constant supply at terminal 1 and 2 for the integrated heater. During commissioning apply a self adjustment drive.

Actuators are maintenance free. An annual inspection is recommended. Actuators must not be opened by the customer.

#### B. Manual override

Manual override only if supply voltage is cut. Use delivered socket wrench with slow motions, usage can be tight.

**Attention:** Releasing or letting go the Allen key too fast at manual operating actuators with spring return causes risk of injury!

#### C. Shaft connection, selection of running time

Actuators are equipped with a direct coupling double square shaft connection of 16 × 16 mm. The housing of the actuator is axially symmetrically built to select Open-close direction of the spring return function by left-right mounting. Using the 10-position switch different motor running times and spring return running times can be selected on site in acc. to the actuator type.

#### D. 3-position control mode

...Max actuators are in the best way suitable for the 3-pos. operation. To protect such elements as gears and mounting elements against harmful influences like minimum pulse time, ...Max actuators are protected via internal electronics. It ignores impulses < 0,5 s, the cyclic duration must be min. 0,5 s. At changing direction the pause is 1 s.

#### E. Spring return

Spring return function works only if the supply voltage for terminal 1 or 2 is cut. In the event of an electrical interruption, the spring returns to its end position even if supply voltage is available again during return function. Thereafter operation will continue.

#### F. Operation at ambient temperatures below -20 °C

All actuators are equipped with a regulated integrated heating device designed for employments down to -40 °C ambient temperature. The heater will be supplied automatically by connecting the constant voltage supply on the clamps 1 and 2.

1. After mounting the actuator must be immediately electrically connected.
2. The heater switches on automatically when actuator reaches internally -20 °C. It heats up the actuator to a proper working temperature, then heater switches off automatically. Actuator will not run during heating process.
3. The adjustment options are only ensured after this heating up period.

#### G. Excess temperatures

All actuators are protected against excess temperature. The internal thermostat works as a maximum limiter and, in the event of failure at incorrect temperatures, shuts off the actuator irreversibly. An upstream connected temperature sensor stops the actuator before reaching its max. temperature. This safety feature is reversible, after cooling down the actuator is completely functional again. In this case the failure must be eliminated immediately on site!

#### H. Synchron mode

Do not connect several actuators to one shaft or link mechanically together.

#### I. Mechanical protection

Actuators must be operated with a minimum external load.

After installing the actuator to the damper/armature a self adjustment drive has to be performed in order to protect the damper/armature against mechanical overload. During operation the actuator reduces briefly its speed (motor power) before reaching the end position for a "gentle" blockade/stop.

### Extra information (see additional data sheet)

Additional technical information, dimensions, installation instruction, illustration and failure indication

#### Accessory InSwitch – auxiliary switch



For an end or inclined position indication it is possible to retrofit external, adjustable auxiliary switches type InSwitch.

The ...Switch is mounted directly to the actuator. The switches deliver a potential free output and can be adjusted separately. They are connected by cable.

#### Accessory InBox – terminal box



For electrical connection of the ...Max actuator a terminal box is required.

To adapt the ...Box directly to the actuator housing a mounting bracket is required.

InBox- Y/S for ...Max-...-Y and ...-YF



## Extra information for ...Max actuators – size M

for optimization of planning, installation and initial startup for safe operation



### Assembly

- ▶ Dimensions, drill plate
- ▶ Control elements: switch – push buttons – LED
- ▶ Outdoor installation
- ▶ Mounting on air dampers (form-fit)
- ▶ Mounting on fire dampers (form-fit)
- ▶ Mounting on butterfly valves and ball valves
- ▶ Mounting of terminal box ...Box and auxiliary switch ...Switch



### Electric

- ▶ Power supply design
- ▶ Line cross sections
- ▶ Problem treatment/error indication

Subject to change!

### ▶ Dimensions

Dimensioning in mm

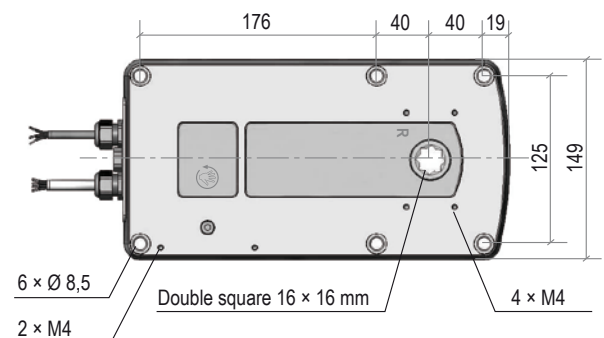
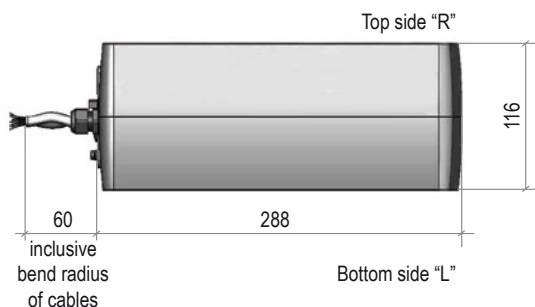

### ▶ Control elements: switch – push button – LED

All actuators are equipped with a 10-position switch, a push button and a multicolour LED for calibration. These control elements are to be found cable-laterally behind the two middle sectioned dummy plugs. For operation these must be removed. The calibration can be achieved despite lining up power supply at the actuator. The explosion prevention is not impaired thereby. However, it has to be of great concern that the dummy plugs must be rescrewed in order to comply with the IP-protection class.

The operation of the switch and button has to be done by means of a small screwdriver. Force with strong pressure and /or rotation is to be avoided in any case, since otherwise control electronics can be damaged irreparably. Adjustments of torque and running time can be achieved also before mounting. The adjustment of angle of rotation can be started only with an outside load and accurate mounting.

#### Switch – Push button – Lamp for adjustment (behind the blanking plug)

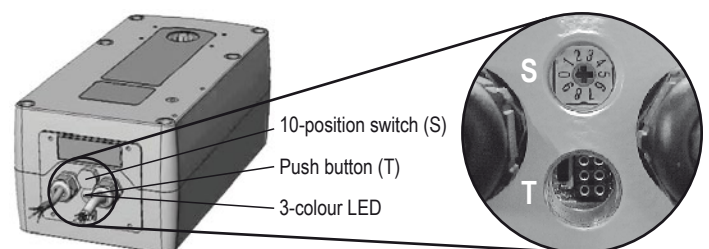

### ▶ Outdoor installation

When mounting actuator outdoors it has to be certain that the actuator is protected against direct sun exposure (heat and UV!), rain and snow by employing an enclosure roof. Supply voltage is to be applied immediately after mounting in order to assure integrated heating at start.

Since actuators must have an internal temperature fuse, they may not be exposed to a too high temperature, neither at storage nor during operation. Otherwise the fuse could respond and switch off the actuator irreversibly.

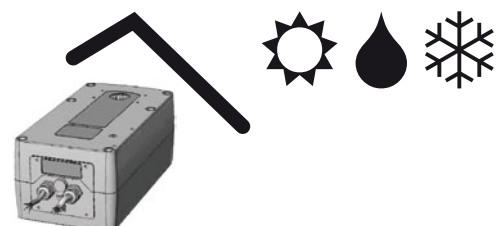

► Mounting of ...Max actuators



...Max actuators size M are equipped with a 16 × 16 mm (double square) shaft connection by default. The form-fitting shaft connection is the most secure connection between damper shaft and actuator because slipping or slipping through is avoided compared to the force-fit clamp-connection.

The actuator will be connected firmly to the damper or fixed to a mounting bracket by means of four screws M8 (scope of delivery).

For square damper shafts 12 × 12 mm or 14 × 14 mm reducing bushes are also available.

The actuators are axially symmetric developed. In case of spring return function the safety position must be selected by turning the actuator to 180°.

Furthermore it is to be considered that the actuators have a total angle movement of approx. 95° in order to realize a pretension on the control element (damper or the like). Therefore the actuator sits tilted on the damper shaft.

In order to adjust this and to induce pretension, the driving shaft has to be aligned mechanically over the hand-operated control socket "HV" when connecting to the damper shaft. The socket wrench has to be turned **counterclockwise** when facing the actuator's "side R", facing "side L" turn manual override **clockwise**.



**Attention: Mount with appropriate safety precautions only!**

- The drive shaft may only be mechanically adjusted either with the provided socket wrench or the optional accessory "HV-MK" manual override (turn off power supply). External force applied to the shaft can lead to mechanical damage of the actuator!
- At the manual override counteracting forces occur when mounting spring return actuators. **Do NOT release manual override under spring tension!**

► Mounting on air dampers



Form-fitted shaft connection – Mounting on square damper shaft

**Mounting:**

1. Affix tap holes M8 (in accordance with drill template) on the damper or to a mounting bracket.
2. Adjust drive shaft of the actuator with the socket wrench that the drive stands perpendicularly to the damper before plugging actuator onto the damper shaft.
3. Plug actuator onto damper shaft and fix diagonally with 2 screws.
4. Remove the socket wrench.
5. Pivot and tighten the remaining screws.

**Dimension of the damper shaft**

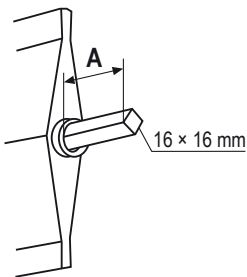

**Length A**

Measure A in acc. with indicator:

1. Actuator without indicator      **A = no limit**
2. Actuator with indicator,  
no accessories                      **A < 95 mm**

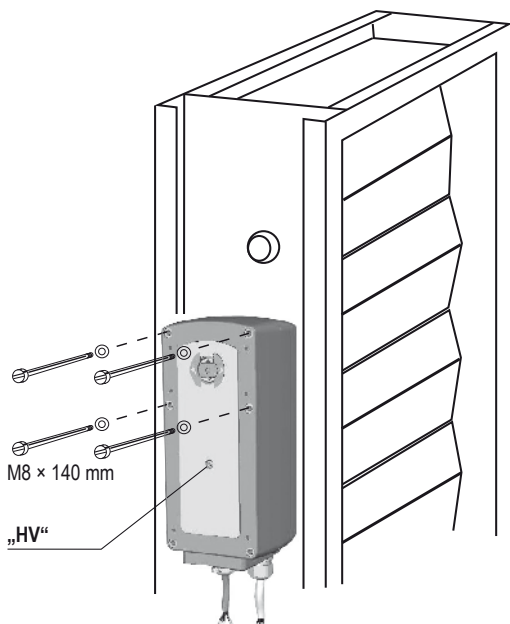

4 screws M8 × 140 mm as well as a socket wrench are part of delivery. For square damper shafts 12 × 12 mm or 14 × 14 mm reducing bushes are available as optional accessories.

► **Mounting on fire dampers**



ExMax-...-BF and RedMax-...-BF actuators integrate an intrinsically safe circuit in order to connect an ExPro-TT-... sensor which works like a temperature trigger. InMax-... and InPro-TT-... are for non hazardous areas.

**Mounting:**

1. Affix tap holes M8 (in accordance with drill template) on the damper or to a mounting bracket
2. Adjust drive shaft of the actuator with the socket wrench that the drive stands perpendicularly to the damper before plugging actuator onto the damper shaft
3. Plug actuator onto damper shaft and fix diagonally with 2 screws
4. Remove the socket wrench
5. Pivot and tighten the remaining screws
6. Mount temperature trigger ...Pro-TT-...
7. Mount terminal box (type ...Box-BF)
8. Plug sensor connector into actuator's socket



**Connection of safety temperature trigger ...Pro-TT-...**



The temperature trigger is mounted directly to the duct or damper wall with pre-assembled tapping screws. The position of the safety elements must guarantee free air flow. ...Pro-TT-... is mounted to the actuator by means of quick fastener M12.

► **Mounting to ball valves and butterfly valves**



Actuators of size M are equipped by default with a 16 × 16 mm double square form-fitting shaft connection. For mounting to butterfly valves or ball valves a special mounting bracket in acc. with DIN EN ISO 5211 is required.

Since this standard provides only certain basic conditions there can be substantial geometrical differences between armatures which require a special adaption.

**Mounting to a ball valve**

**Mounting to a butterfly valve**

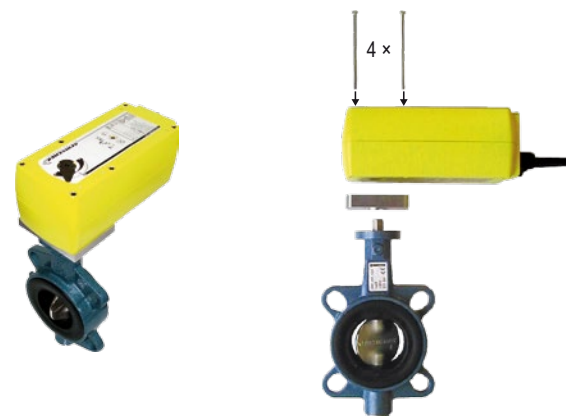
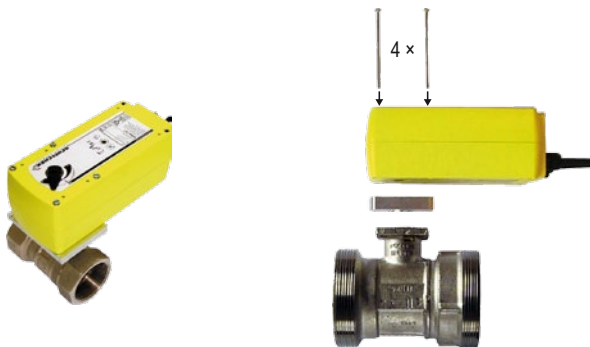

► **Mounting of terminal boxes ...Box to actuator via mounting bracket MKK-M (accessory)**

- A) Screw mounting bracket MKK-M with 4 screws to actuator
- B) Screw terminal box to mounting bracket

Mounting bracket can be mounted every 90°

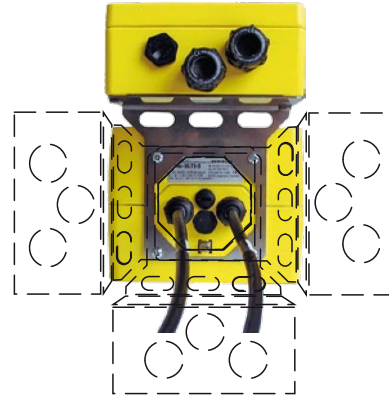
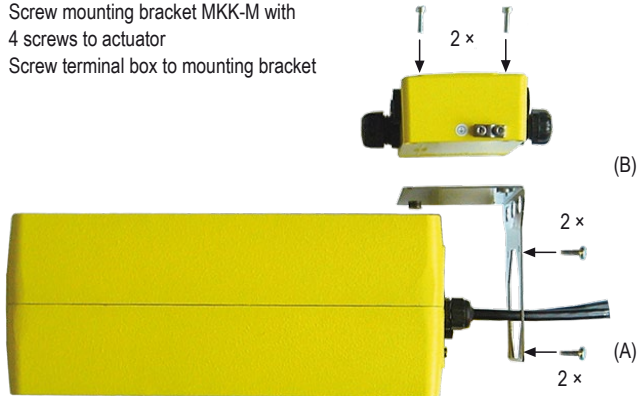

Terminal box mounted above the actuator

Terminal box mounted beside the actuator

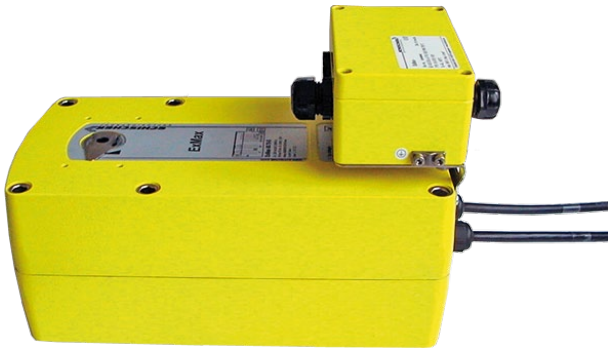

► **Mounting of auxiliary switch ...Switch to actuator**

- A) Place square connection part on actuator's shaft
- B) Mount ...Switch and fix it with screws

...Max with mounted ...Switch

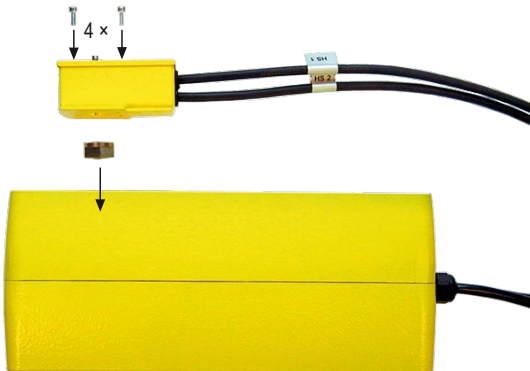

(B)

(A)

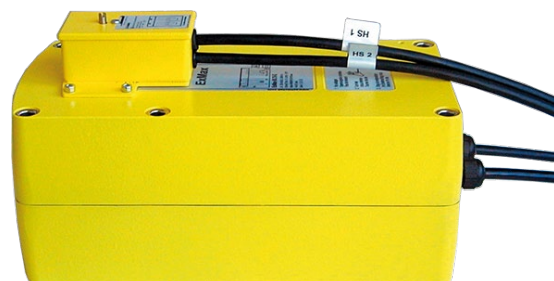



**► Power input depending on supply voltage**

The design of the on-site supply depends on the selected motor running time and selected supply voltage. Accompanying values are "about values" since there can be construction unit dispersions within electronics. The holding power is run time independently typical at ~ 5 W. The power consumption for the heater is ~ 16 W. In the heating phase the motor is not active!

The initial starting supply voltage required by the actuators power supply unit is ~ 2.0 A. The starting pulse takes about 1 sec. (please consider this while conceiving the cross section of the supply line). The power factor is between 0.8 and 0.5 in dependence of motor running time. A line protection should be min. 2 AT.

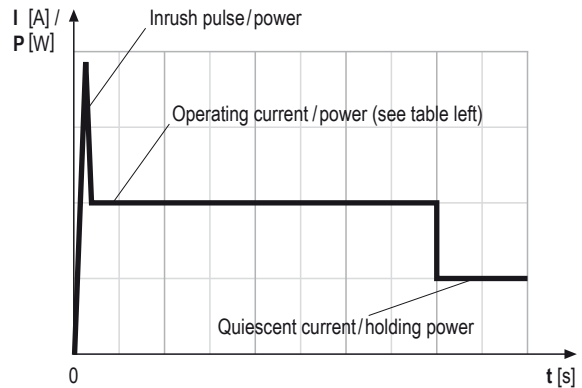

**Rated current in acc. with motor running time**

Voltage	Current	Rated current in acc. with motor running time				
		40 s	60 s	90 s	120 s	150 s
24 V DC	I <sub>Nominal</sub>	1,5 A	1,0 A	0,8 A	0,7 A	0,7 A
120 V AC	I <sub>Nominal</sub>	0,26 A	0,18 A	0,14 A	0,12 A	0,12 A
240 V AC	I <sub>Nominal</sub>	0,13 A	0,09 A	0,07 A	0,06 A	0,06 A

**► Cross sections of the inlet line**

On long distances between voltage supply and drive, voltage drops occur due to line resistances. As a consequence with 24 VAC/DC the actuator receives a too low tension and does not start. In order to prevent this the cross section of the inlet line is to be dimensioned accordingly.

The accompanying formulas allow the calculation of the necessary line cross section respectively maximal permitted conduit length respectively utilizing the existing line cross section.

Alternatively the secondary voltage can be increased by selecting a transformer.

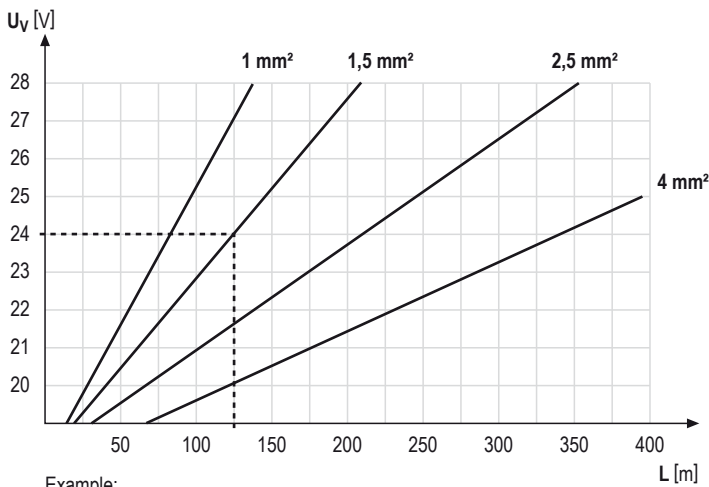
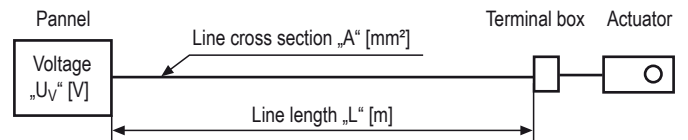

Example:  
24 V power supply with wire diameter 1.5 mm<sup>2</sup> = cable length 126 m

Required **cable cross section A** at existing cable length L

$$A = 0,0714 \times L : (U_V - 18 V)$$

Example: L = 250 m, U<sub>V</sub> = 30 V  
Cross section A = 1,5 mm<sup>2</sup>

Maximum **cable length L** at existing cross section A

$$L = A \times (U_V - 18 V) : 0,0714$$

Example: A = 1.5 mm<sup>2</sup>, U<sub>V</sub> = 24 V  
Length of cable L = 126 m

For calculation following characteristics are essential:

- U<sub>V</sub> = supply voltage [V]
- A = line cross section [mm<sup>2</sup>]
- L = conduit length [m]
- Factor 0.0714 = drive specific factor [Vmm<sup>2</sup>/m]  
(based on the electrical conductivity of electrolytic copper with a coefficient of 56 m/Ωmm<sup>2</sup>)



► Problem handling / Error indication



Problem	Possible cause	Course of action
01 Actuator does not work LED does not light	<ul style="list-style-type: none"> <li>No power supply attached</li> <li>The actuator is operated at ambient temperature beyond specifications and the internal temperature fuse shuts down irreversibly</li> </ul>	<ul style="list-style-type: none"> <li>Attach power supply and turn on</li> <li>Caused by inadmissible operation and for safety relevant reasons the actuator drove into an irreversible condition and must be exchanged. accompanying new installation the ambient temperature has to be reduced accordingly</li> </ul>
02 Actuator does not work LED lights RED	<ul style="list-style-type: none"> <li>The actuator is operated at a too high ambient temperature and the internal temperature sensor responded</li> <li>...-BF actuators require a temperature trigger type ...Pro-TT or FireSafe</li> </ul>	<ul style="list-style-type: none"> <li>Shut off actuator and let temperature decrease, reduce ambient temperature by suitable measures e.g. ventilation or other mounting position of the actuator</li> <li>Connect trigger, LED changes to GREEN, actuator is ready-to-operate</li> </ul>
03 Actuator does not work LED lights GREEN	<ul style="list-style-type: none"> <li>3-pos. control signal is wired on both entrances</li> <li>Required torque is greater than actuators torque</li> <li>Control signals are not attached or attached on a wrong conductor</li> <li>Actuator is incorrectly mounted and is blocked by an external stop unit</li> <li>Interchanged supply lines</li> </ul>	<ul style="list-style-type: none"> <li>Readjust / correct circuit</li> <li>Adjust a higher torque at the actuator if possible otherwise exchange for a type with higher torque</li> <li>Examine rule and adjusting signals and connect in accordance with diagram</li> <li>Dismount actuator and testdrive without load for operability. Then install actuator accordingly so that the power transmission of the actuator runs the armature/damper without external blockade or torsion</li> <li>Switch wires: 1 must be connected to (-, N) and wire 2 to (+, L)</li> </ul>
04 Actuator does not work LED is blinking RED	<ul style="list-style-type: none"> <li>The actuator has been mounted at temperatures &lt; -20 °C and did not reach its operating temperature of at least -20 °C</li> </ul>	<ul style="list-style-type: none"> <li>Ensure that a constant voltage supply is applied on conductor 1–2</li> <li>Wait until the required operating temperature is achieved by the actuators internal heating system. The actuator will start operating independently</li> </ul>
05 Y-drive in 3-pos. mode cannot gear into intermediate positions	<ul style="list-style-type: none"> <li>The conversion of constant mode to 3-pos. mode was not set</li> </ul>	<ul style="list-style-type: none"> <li>Recalibrate the actuator in accordance with assembly instructions</li> </ul>
06 Actuator sits diagonally on square damper shaft	<ul style="list-style-type: none"> <li>Actuators have an angle of rotation of 95° incl. 5° pretension. While assembling the pre-load was not considered</li> </ul>	<ul style="list-style-type: none"> <li>Dismount actuator off the damper, use enclosed socket wrench to draw up approx. 5° over the hand operated control device before remounting on the damper shaft. Consider assembly instructions!</li> </ul>
07 A modulating Y-actuator working with reduced angle of rotation, reaches its end positions already at > 0 V/4 mA resp. < 10 V/20 mA	<ul style="list-style-type: none"> <li>At start up no self-adjustment of angle of rotation was accomplished</li> </ul>	<ul style="list-style-type: none"> <li>Accomplish self adjustment of angle of rotation in accordance with assembly instruction</li> </ul>
08 LED flashes irregularly and actuator does not work	<ul style="list-style-type: none"> <li>Actuator does not receive sufficient supply voltage</li> <li>Cable to long, voltage drop in the supply line to large</li> </ul>	<ul style="list-style-type: none"> <li>Increase line cross section or power supply</li> <li>Increase line cross section or power supply</li> </ul>

# SALES CONTACT



[www.airmax-hvac.com](http://www.airmax-hvac.com)



080-614-4944, 063-268-8080



@airmax (Line Official)



[windcontrol.info@gmail.com](mailto:windcontrol.info@gmail.com)



**Address**

เลขที่ 56/392 หมู่ที่ 12  
ตำบลศีรษะจรเข้น้อย  
อำเภอบางเสาธง  
จังหวัดสมุทรปราการ  
10540